



Downlight System

DWL 32W 75° C90 IP54 BI SDB 4K

Beghelli
IDEE PIENE DI VITA

Codice ordine 40356

EAN 8002219896957

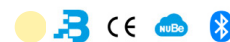

Specifiche tecniche

Potenza assorbita	32 W
Tipo di tensione di alimentazione	AC/DC
Tensione alimentazione (AC)	230 Vac
Temperatura ambiente (min)	-20 °C
Temperatura ambiente (max)	40 °C
Classe di isolamento	II
CCT tonalità luce	4000 K
Grado di protezione ottica	IP54/IP20
Numero LED	1
Corrente di uscita (max)	800
Rischio fotobiologico	RG0
Angolo fascio luminoso	75 °
Stabilità colore	SDCM3
Colore riflettore	Bianco
CRI Resa cromatica	>90
Diametro	145 mm
Tipo driver	SDB
Ballast	Per LED a corrente costante (DALI)
Efficienza	110 lm/W
Frequenza (max)	60 Hz
Frequenza (min)	50 Hz
Res. filo incandescente	850 °C - 30s.
Corrente Inrush	25 A
Tempo di transizione Inrush	0,2
Efficienza ottica	100%, 100%
Flusso apparecchio	3500 lm
Installazione	Incasso, Incasso in Controsoffitti
Tensione alimentazione (DC)	216 Vdc
Range tensione alimentazione (DC)	180÷264 VOLT
Range tensione alimentazione (max)	253 V
Range tensione alimentazione (min)	207 V

Installazione e applicazioni

Ambiente	Uffici
Applicazione	Uffici, Hotel, Scuole

Specifiche meccaniche

Altezza	138 mm
Lunghezza di taglio	130 mm
Materiale corpo	Alluminio pressofuso
Colore corpo	Bianco
Materiale riflettore	Alluminio Verniciato Bianco

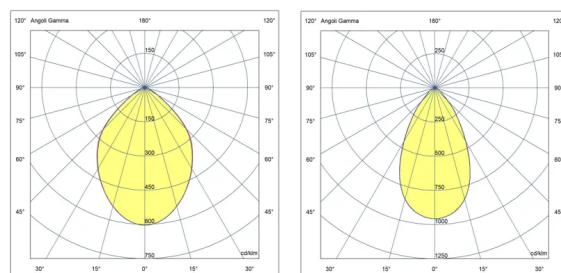
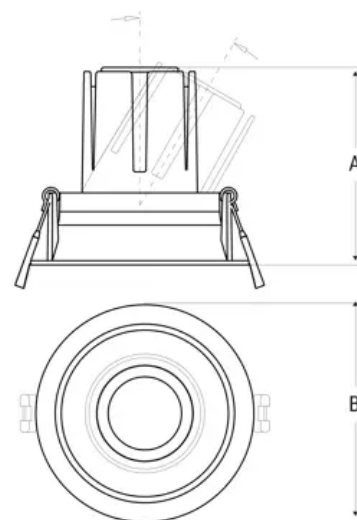



Grado di protezione vano alimentazione	IP20
Grado di protezione IP	IP54/IP20
Grado di protezione IK	IK05

Certificati e normative

EN IEC 55015:2019 + A11:2020, EN IEC 61000-3-2 :2019, EN 61000-3-3:2013, EN 61547:2009, EN 62471:2008, EN IEC 60598-1:2021, EN 60598-2-2:2012, EN 62493:2010, EN 301 489-1 V2.2.3, EN 301 489-17 V3.2.4

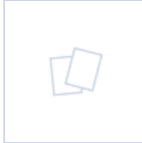
Accessori

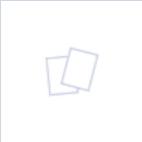
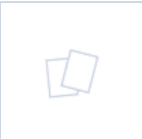
	40478 DOUBLE FILTER 32W		40466 HONEYCOMB 32W		40481 ADAPTER RING 32W 130 TO 220MM
	40474 NARROW FILTER 32W		40470 OVAL FILTER 32W		70059 KIT CAVETTO DI SICUREZZA
	40462 RIF ROUND 32W TITANIUM				

Accessori domotica

	15062 SENSORE PRES BLE UFFICI IP40		15054 MOD AUTODIM RADIO IP40		15064 CONCENTRATORE WIFI BLE
	15076 SENSORE AUTODIMMER RJ45		15065 TRASMETTITORE BLE		21102 CENTRALE DOMOTICA SD-LGFM
	20104 TRASMETTITORE RADIO DOMOTICO		15074 CONC WiFi BLE ETHERNE EASY BOX		15063 SENSORE PRESE BLE INDUSTRI IP65

Accessori inverter

	19398 INV UNIV AT RM 5W 20-240V		15037 MODULO LGFM		15080 MODULO DALI SLIM
	19359 INV P&L LED SE/SA 3H 20-60V		15079 MODULO LG SLIM		19399 INV UNIV CT 5W 20-240V
	19358 INV P&L LED SE/SA 1H 20-60V				