



Downlight System

DWL 24W 75° C90 IP54 BI SDB 3K

Beghelli
IDEE PIENE DI VITA

Codice ordine 40385

EAN 8002219897190

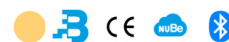

Specifiche tecniche

Potenza assorbita	24 W
Tipo di tensione di alimentazione	AC/DC
Tensione alimentazione (AC)	230 Vac
Temperatura ambiente (min)	-20 °C
Temperatura ambiente (max)	40 °C
Classe di isolamento	II
CCT tonalità luce	3000 K
Grado di protezione ottica	IP54/IP20
Numero LED	1
Corrente di uscita (max)	600
Rischio fotobiologico	RG0
Angolo fascio luminoso	75 °
Stabilità colore	SDCM3
Colore riflettore	Bianco
CRI Resa cromatica	>90
Diametro	125 mm
Tipo driver	SDB
Ballast	Per LED a corrente costante (DALI)
Efficienza	110 lm/W
Frequenza (max)	60 Hz
Frequenza (min)	50 Hz
Res. filo incandescente	850 °C - 30s.
Corrente Inrush	25 A
Tempo di transizione Inrush	0,24
Efficienza ottica	100%, 100%
Flusso apparecchio	2600 lm
Installazione	Incasso, Incasso in Controsoffitti
Tensione alimentazione (DC)	216 Vdc
UGR	19
Range tensione alimentazione (DC)	180÷264 VOLT
Range tensione alimentazione (max)	253 V
Range tensione alimentazione (min)	207 V

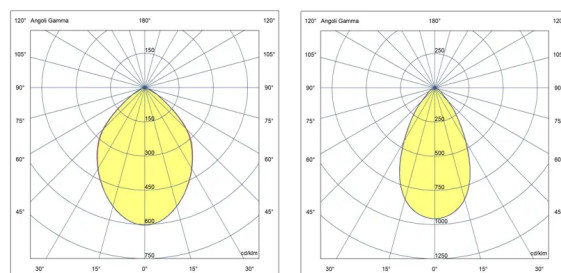
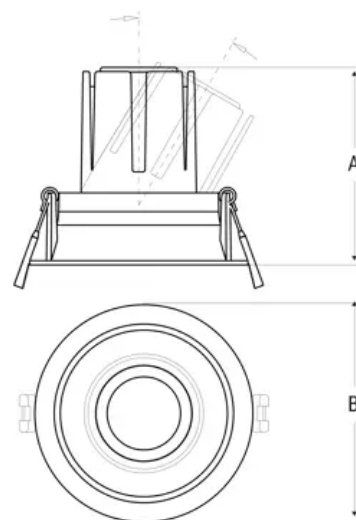

Installazione e applicazioni

Ambiente	Uffici
Applicazione	Uffici, Hotel, Scuole

Specifiche meccaniche





Altezza	117 mm
Lunghezza di taglio	110 mm
Materiale corpo	Alluminio pressofuso
Colore corpo	Bianco

Materiale riflettore	Alluminio Verniciato Bianco
Grado di protezione vano alimentazione	IP20
Grado di protezione IP	IP54/IP20
Grado di protezione IK	IK05

Certificati e normative

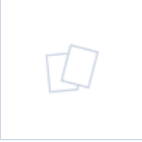
EN IEC 55015:2019 + A11:2020, EN IEC 61000-3-2 :2019, EN 61000-3-3:2013, EN 61547:2009, EN 62471:2008, EN IEC 60598-1:2021, EN 60598-2-2:2012, EN 62493:2010, EN 301 489-1 V2.2.3, EN 301 489-17 V3.2.4

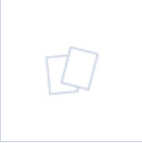
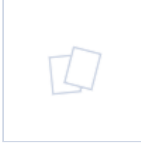
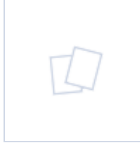
Accessori

	40465 HONEYCOMB 24W		40461 RIF ROUND 24W TITANIUM		70059 KIT CAVETTO DI SICUREZZA
	40480 ADAPTER RING 24W 110 TO 220MM		40469 OVAL FILTER 24W		40477 DOUBLE FILTER 24W
	40473 NARROW FILTER 24W				

Accessori domotica

	15054 MOD AUTODIM RADIO IP40		15062 SENSORE PRES BLE UFFICI IP40		15065 TRASMETTITORE BLE
	15074 CONC WiFi BLE ETHERNE EASY BOX		20104 TRASMETTITORE RADIO DOMOTICO		15076 SENSORE AUTODIMMER RJ45
	15064 CONCENTRATORE WIFI BLE		21102 CENTRALE DOMOTICA SD-LGFM		15063 SENSORE PRESE BLE INDUSTRI IP65

Accessori inverter

	19399 INV UNIV CT 5W 20-240V		15080 MODULO DALI SLIM		15037 MODULO LGFM
	19398 INV UNIV AT RM 5W 20-240V		19358 INV P&L LED SE/SA 1H 20-60V		19359 INV P&L LED SE/SA 3H 20-60V
	15079 MODULO LG SLIM				