



Flood Modula M

FLOOD M SDB 180 R AS 3K

Beghelli
IDEE PIENE DI VITA

Codice ordine 43147

EAN 8002219900579

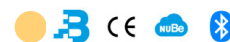

Specifiche tecniche

Potenza assorbita	180 W
Tipo di tensione di alimentazione	AC/DC
Tensione alimentazione (AC)	230 Vac
Temperatura ambiente (min)	-20 °C
Temperatura ambiente (max)	40 °C
Classe di isolamento	I
CCT tonalità luce	3000 K
Numero LED	24
Corrente di uscita (max)	840
Stabilità colore	SDCM3
CRI Resa cromatica	>70
Tipo driver	SDB
Ballast	Per LED a corrente costante (DALI)
Efficienza	157 lm/W
Esposizione al vento	1089
Frequenza (max)	60 Hz
Frequenza (min)	50 Hz
Res. filo incandescente	960 °C - 30s.
Corrente Inrush	80 A
Tempo di transizione Inrush	0,35
Flusso apparecchio	28260 lm
Flusso luminoso L70B10	284000 h
Flusso luminoso L70B50	398000 h
Flusso luminoso L80B10	180000 h
Flusso luminoso L80B20	200000 h
Flusso luminoso L80B50	248000 h
Flusso luminoso L90B10	100000 h
Flusso luminoso L90B50	118000 h
Tensione alimentazione (DC)	216 Vdc
Interruttori B16 (n. max)	6
Interruttori C16 (n. max)	10
Protezione scarica elettrica	10 kV
Range tensione alimentazione (DC)	176÷276 VOLT
Range tensione alimentazione (max)	253 V
Range tensione alimentazione (min)	207 V

Specifiche meccaniche

Altezza	70 mm
Lunghezza	409 mm
Larghezza	353 mm
Peso	6,4 Kg

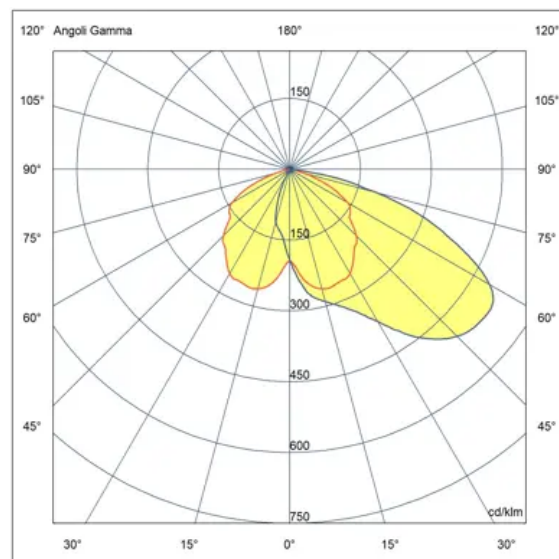
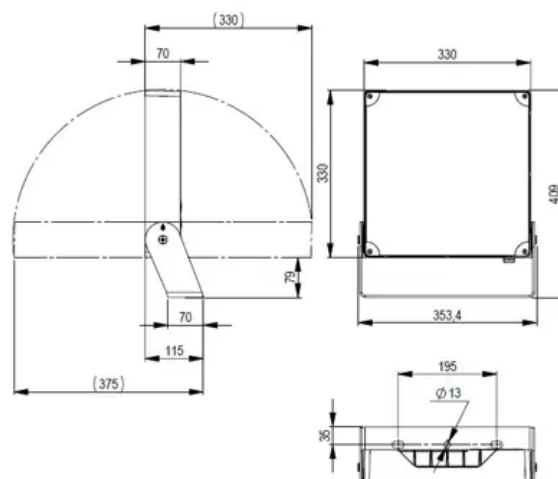

Materiale corpo	Alluminio pressofuso
Colore corpo	Grigio
Materiale cover	Vetro temprato
Materiale riflettore	Alluminio Satinato
Grado di protezione IP	IP66
Grado di protezione IK	IK08

Certificati e normative

EN IEC 55015:2019 + A11:2020, EN IEC 61000-3-2 :2019, EN 61000-3-3:2013, EN 61547:2009, EN 60598-2-5:2015, EN 62471:2008, EN IEC 60598-1:2021, EN 62493:2010, EN 301 489-1 V2.2.3, EN 301 489-17 V3.2.4

Accessori



12663
CAVO SOSPENSIONE
RIFLETTORE



12667
GRIGLIA FLOOD MODULA M

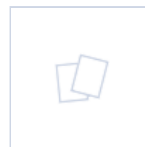

12669
GOLFARI M5 FLOOD
MODULA

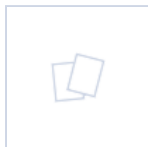

15174
CONC WiFi BLE EASY BOX

Accessori domotica



15054
MOD AUTODIM RADIO IP40



15065
TRASMETTITORE BLE



15053
MOD AUTODIM IP40

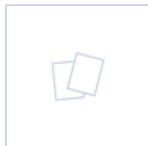

15062
SENSORE PRES BLE UFFICI
IP40



15074
CONC WiFi BLE ETHERNE
EASY BOX



15063
SENSORE PRESE BLE
INDUSTR IP65



21102
CENTRALE DOMOTICA SD-
LGFM

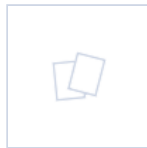

15064
CONCENTRATORE WIFI BLE

Accessori inverter



15069
MODULO TR 6W 1/3H
PROIETTORI



15070
MODULO LG230 PROIETTORI



15071
MODULO LG24 PROIETTORI